



DVD Digital Home Cinema System



*Let's make things better.*



**PHILIPS**



## Important Note

### Important notes for users in the U.K.

#### Mains plug

This apparatus is fitted with an approved 13 Amp plug. To change a fuse in this type of plug proceed as follows:

- 1 Remove fuse cover and fuse.
- 2 Fix new fuse which should be a BS1362 5 Amp, A.S.T.A. or BSI approved type.
- 3 Refit the fuse cover.

If the fitted plug is not suitable for your socket outlets, it should be cut off and an appropriate plug fitted in its place.

If the mains plug contains a fuse, this should have a value of 5 Amp. If a plug without a fuse is used, the fuse at the distribution board should not be greater than 5 Amp.

*Note: The severed plug must be disposed of to avoid a possible shock hazard should it be inserted into a 13 Amp socket elsewhere.*

#### How to connect a plug

The wires in the mains lead are coloured with the following code: blue = neutral (N), brown = live (L).

- As these colours may not correspond with the colour markings identifying the terminals in your plug, proceed as follows:
  - Connect the blue wire to the terminal marked N or coloured black.
  - Connect the brown wire to the terminal marked L or coloured red.
  - Do not connect either wire to the earth terminal in the plug, marked E (or  $\perp$ ) or coloured green (or green and yellow).

Before replacing the plug cover, make certain that the cord grip is clamped over the sheath of the lead - not simply over the two wires.

#### Copyright in the U.K.

Recording and playback of material may require consent. See Copyright Act 1956 and The Performer's Protection Acts 1958 to 1972.

**This product complies with the radio interference requirements of the European Community.**

### CAUTION

**Use of controls or adjustments or performance of procedures other than herein may result in hazardous radiation exposure or other unsafe operation.**

### Italia

#### DICHIARAZIONE DI CONFORMITA'

Si dichiara che l'apparecchio MX-3800D Philips risponde alle prescrizioni dell'art. 2 comma 1 del D.M. 28 Agosto 1995 n. 548.

Fatto a Eindhoven

Philips Consumer Electronics  
Philips, Glaslaan 2  
5616 JB Eindhoven, The Netherlands

### Norge

Typeskilt finnes på apparatens underside.

**Observer: Nettbryteren er sekundert innkoplet. Den innebygde nettdelen er derfor ikke frakoplet nettet så lenge apparatet er tilsluttet nettkontakten.**

For å redusere faren for brann eller elektrisk støt, skal apparatet ikke utsettes for regn eller fuktighet.

### DK

**Advarsel: Usynlig laserstråling ved åbning når sikkerhedsafbrydere er ude af funktion. Undgå udsættelse for stråling.**

**Bemærk: Netafbryderen er sekundært indkoblet og afbryder ikke strømmen fra nettet. Den indbyggede netdel er derfor tilsluttet til lysnettet så længe netstikket sidder i stikkontakten.**

### S

#### Klass 1 laserapparat

**Varning! Om apparaten används på annat sätt än i denna bruksanvisning specificerats, kan användaren utsättas för osynlig laserstråling, som överskrider gränsen för laserklass 1.**

**Observera! Stömbrytaren är sekundärt kopplad och bryter inte strömmen från nätet. Den inbyggda nätdelen är därför ansluten till elnätet så länge stickproppen sitter i vägguttaget.**

### SF

#### Luokan 1 laserlaite

**Varoitus! Laitteen käyttäminen muulla kuin tässä käyttöohjeessa mainitulla tavalla saattaa altistaa käyttäjän turvallisuusluokan 1 ylittävälle näkymättömälle lasersäteilylle.**

**Oikeus muutoksiin varataan. Laite ei saa olla alttiina tippu- ja roiskevedelle.**

**Huom. Toiminnanvalitsin on kytketty toisipuolelle, eikä se kytke laitetta irti sähköverkosta. Sisäänrakennettu verkko-osa on kytkettyä sähköverkkoon aina silloin, kun pistoke on pistorasiassa.**



# Index

English .....	5
Français .....	25
Español .....	45
Deutsch .....	65
Nederlands .....	85
Italiano .....	105
Svenska .....	125
Dansk .....	145
Suomi .....	165
Português .....	185
Ελληνικά .....	205
Polski .....	225





**CAUTION**

VISIBLE AND INVISIBLE LASER RADIATION WHEN OPEN AVOID EXPOSURE TO BEAM

**ADVARSEL**

SYNLIG OG USYNLIG LASERSTRÅLING VED ÅBNING  
UNDGÅ UDSÆTTELSE FOR STRÅLING

**VARNING**

SYNLIG OCH OSYNLIG LASERSTRÅLNING NÄR  
DENNA DEL ÄR ÖPPNAD BETRakta EJ STRÅLEN

**VARO!**

AVATTAESSA OLET ALTTIINA NÄKYVÄLLE JA  
NÄKYMÄTTÖMÄLLE LASER SÄTEILYLLE. ÄLÄ KATSO  
SÄTEESEEN

**VORSICHT**

SICHTBARE UND UNSICHTBARE LASERSTRAHLUNG  
WENN ABDECKUNG GEÖFFNET NICHT DEM  
STRAHL AUSSETZEN

**ATTENTION**

RAYONNEMENT LASER VISIBLE ET INVISIBLE EN CAS  
D'OUVERTURE EXPOSITION DANGEREUSE AU  
FAISCEAU

**WARNING:** Due to the fact that the mains switch of sub-woofer was located at the rear panel, the apparatus must be located in an open area without any obstructions to access the mains switch.

**WARNING:** To prevent fire or shock hazard, do not expose this equipment to rain or moisture.

**ATTENTION:** L'interrupteur d'alimentation se trouve à l'arrière du caisson de basses et par conséquent, vous devrez laisser assez d'espace autour de l'appareil sans obstacles pour pouvoir accéder à l'interrupteur.

**ATTENTION:** Pour éviter les chocs électriques ou les risques de flamme, n'exposez pas cet appareil à la pluie ou à l'humidité.

**ADVERTENCIA:** Debido a que el interruptor de conexión a la red eléctrica del sub-woofer está situado en el panel trasero, el aparato debe estar situado en un área abierta y sin obstrucciones para el acceso a dicho interruptor.

**ADVERTENCIA:** Para evitar riesgos de incendio o sacudidas eléctricas, no exponga este equipo a la lluvia o a la humedad.

**WARNHINWEIS:** Aufgrund der Tatsache, dass sich der Netzschalter des Subwoofers auf der Rückwand befindet, muss das Gerät in einem offenen Bereich aufgestellt werden, damit der Netzschalter völlig ungehindert zugänglich ist.

**WARNHINWEIS:** Dieses Gerät weder Regen noch Feuchtigkeit aussetzen, um der Brand- bzw. Stromschlaggefahr vorzubeugen.

**WAARSCHUWING:** Gezien het feit dat de aan/uit-schakelaar van de subwoofer op de achterkant van het apparaat zit, dient er rondom het apparaat ruimte te zijn zodat men zonder problemen bij de aan/uit-schakelaar kan komen.

**WAARSCHUWING:** Houd het apparaat uit de buurt van regen of vocht om het risico op schokken of brand te vermijden.

**AVVERTENZA:** L'interruttore d'alimentazione del subwoofer si trova sulla parte posteriore dell'apparecchio e dunque controllare che lo spazio intorno all'apparecchio sia sufficiente e senza ostacoli per accedere all'interruttore.

**AVVERTENZA:** Per evitare il pericolo di scosse elettriche o di incendio, non esporre l'apparecchio a pioggia o umidità.

**WARNING:** På grund av att subwoofers strömbrytare sitter på bakre panelen, måste apparaten ställas fritt så att strömbrytaren är lätt åtkomlig.

**WARNING:** För att förhindra risken för brand eller elektrisk stöt får denna utrustning inte utsättas för regn eller fuktighet.

**ADVARSEL:** Fordi subwoofers netafbryder sidder på bagpanelet, skal apparatet anbringes på et åbent sted uden forhindringer, så der er let adgang til netafbryderen.

**ADVARSEL:** For at undgå risiko for brand eller elektriske stød må dette udstyr ikke udsættes for regn eller fugtighed.

**VAROITUS:** Koska alabassokaiuttimen virtakytkin sijaitsee takapaneelilla, laite on asetettava avoimeen tilaan virtakytkimen käyttöön mahdollistamiseksi esteettä.

**VAROITUS:** Tulipalon ja sähköiskuvaaran ehkäisemiseksi älä altista tätä laitetta sateelle tai kosteudelle.

**ATENÇÃO:** O interruptor de alimentação do subwoofer encontra-se na parte de trás do aparelho; certifique-se de que existe espaço suficiente em volta do aparelho e sem obstáculos para ter acesso ao interruptor.

**ATENÇÃO:** Para evitar o risco de choque ou de incêndio, não exponha o aparelho a chuva ou humidade.

**ΠΡΟΕΙΔΟΠΟΙΗΣΗ:** Επειδή ο διακόπτης ισχύος του subwoofer βρίσκεται στον πίσω πίνακα, η συσκευή θα πρέπει να τοποθετείται έτσι ώστε να υπάρχει αρκετός ελεύθερος χώρος χωρίς να παρεμποδίζεται η πρόσβαση στον διακόπτη ισχύος.

**ΠΡΟΕΙΔΟΠΟΙΗΣΗ:** Για να αποφύγετε τον κίνδυνο πυρκαγιάς ή ηλεκτροπληξίας, μην εκθέτετε αυτή τη συσκευή σε βροχή ή υγρασία.

**UWAGA:** Wyłącznik zasilania znajduje się na tylnym panelu. Z tego powodu subwoofer musi stać w wolnej przestrzeni i nie może utrudniać dostępu do wyłącznika.

**UWAGA:** Ze względu na niebezpieczeństwo porażenia prądem lub powstania pożaru, nie wolno narażać opisywanego urządzenia na deszcz lub wilgoć.

Manufactured under license from Dolby Laboratories. "Dolby" and the double-D symbol are trademarks of Dolby Laboratories. Confidential Unpublished Works. ©1992-1997 Dolby Laboratories, Inc. All rights reserved.

Manufactured under license from Digital Theater Systems, inc. US Pat. No. 5,451,942 and other worldwide patents issued and pending. "DTS" and "DTS Digital Surround" are trademarks of Digital Theater Systems, Inc. 1996 Digital Theater Systems, Inc. All rights reserved.

This product incorporates copyright protection technology that is protected by method claims of certain U.S. patents and other intellectual property rights owned by Macrovision Corporation and other rights owners. Use of this copyright protection technology must be authorized by Macrovision Corporation, and is intended for home and other limited viewing uses only unless otherwise authorized by Macrovision Corporation. Reverse engineering or disassembly is prohibited.

**CE** The DVD VIDEO player is in conformity with the EMC directive and low-voltage directive.

**Laser**

Type	Semiconductor laser GaAlAs
Wave length	650nm
Output Power	7mW
Beam divergence	60 degree



# Contents

English

## Introduction and General Information

Features .....	6
Discs for playback .....	6
Player zone .....	
Supplied accessories .....	6
Environmental information .....	6
Installation .....	6
Maintenance .....	6

## Functional Overview

Front and Rear panels .....	7
Remote Control .....	8

## Connections

Connecting antennas .....	9
MW Indoor Loop Antenna .....	
FM Indoor Antenna .....	
FM Outdoor Antenna .....	
Connecting the speakers .....	10
Connecting a TV and additional components .....	10

## Preparations

Inserting batteries into the remote control .....	11
Switching on the system .....	11
Setting up the surround sound system .....	11–12
Placing the speakers .....	
Changing the volume level .....	
Setting up the subwoofer .....	12
System Setup (DVD) .....	12–14
General operation .....	
Setting the picture .....	
Setting the sound .....	
Setting the language .....	
Setting the features .....	

## Basic Functions

Selecting the surround sound mode .....	15
Selecting the digital sound effect .....	15
Volume control .....	16
Adjusting the tone .....	16
Dimming the display screen .....	16

## Operations

Discs information .....	17
Basic playback .....	17–18
Skipping to another track/chapter .....	
Fast Search .....	
Continue playback from the last stop point .....	
Repeat play .....	
Repeat A-B .....	
Programme favourite tracks .....	
Special DVD/VCD features .....	18–20
Changing subtitle language .....	
Changing sound track language .....	
Playing in slow motion mode .....	
Searching for a particular passage .....	
Display the disc information during playback .....	
Moving to another title/chapter .....	
Playback from a selected point .....	
Zooming in .....	
Viewing from another angle .....	
Advancing by frames .....	
Checking the contents of DVD .....	
Special VCD/SVCD features .....	20
Playback Control (PBC) .....	
Special MP3-CD features .....	21
MP3-CD menu .....	

## Other Functions

Tuning to radio stations .....	22
Presetting radio stations .....	22
Listening to preset radio stations .....	22
Sleep timer setting .....	22

## Specifications .....

## Troubleshooting .....



# Introduction and General Information

## Features

Your complete 7-piece 350-Watt DVD Digital Home Cinema System creates the same dynamic sound qualities that you find in full-fledged cinemas and incorporates some of the best features in home theatre technology.

Other features include:

### **Built-in DTS and Dolby® Digital decoder, supporting Dolby® ProLogic and virtual surround**

Lets you use the Home Cinema Audio System for a movie-theatre surround sound experience.

### **Additional Component Connections**

Lets you connect other audio and audio/visual components to the DVD system so you can use the system's surround sound speakers.

### **Night Mode**

Lets you compress the dynamic range, reducing the difference in loudness between different sounds in Dolby Digital mode.

### **Parental Control (Rating Level)**

Lets you set a ratings level so that your children cannot watch a DVD that has a rating higher than you set.

### **Sleep Timer**

Enables the system to switch to standby mode automatically at a preset time.

## Discs for playback

Your DVD player is able to play :

- **All pre-recorded audio CDs**
- **All finalised audio CDR and audio CDRW discs**
- **All VCDs, SuperVCDs and DVDs**
- **MP3-CDs (CD-ROMs with MP3 tracks)**



### **Player zone**

DVD discs and players are designed with regional restrictions. Before playing a disc, make sure the disc is the same zone as your player.



**The region code for this DVD player is 2.**

## Supplied accessories

- a remote control with two AA batteries
- an MW loop antenna and an FM wire antenna
- an audio cable and Scart cable for connection with the TV
- five satellite speakers, including five speaker cables
- an active subwoofer; including a connection cable and a power cable
- a power cable for connection with the main unit
- this instruction booklet

If any item is damaged or missing, contact your retailer or Philips.

## Environmental information

All unnecessary packaging has been omitted. We have tried to make the packaging easy to separate into three materials: cardboard (box), polystyrene foam (buffer) and polyethylene (bags, protective foam sheet).

Your system consists of materials which can be recycled and reused if disassembled by a specialised company. Please observe the local regulations regarding the disposal of packaging materials, exhausted batteries and old equipment.

## Installation

- Place the player on a flat, hard, and stable surface.
- There must be sufficient room in front of the player for the drawer to open.
- In a cabinet, allows about 10cm (4 inches) of free space all around the player for adequate ventilation.
- Do not expose your player to extreme temperatures or humidity.

## Maintenance

- When a disc becomes dirty, clean it with a cleaning cloth. Wipe the disc from the center out, in a straight line.
- Do not expose the player, batteries or discs to humidity, rain, sand or excessive heat (caused by heating equipment or direct sunlight). Always keep the disc tray closed to avoid dust on the lens.
- Do not use solvents such as benzene, thinner, commercially available cleaners, or anti-static spray intended for colour discs.
- The lens may cloud over when the player is suddenly moved from cold to warm surroundings, making it impossible to play a disc. Leave the player in the warm environment until the moisture evaporates.





# Functional Overview

English

## Front and Rear panels

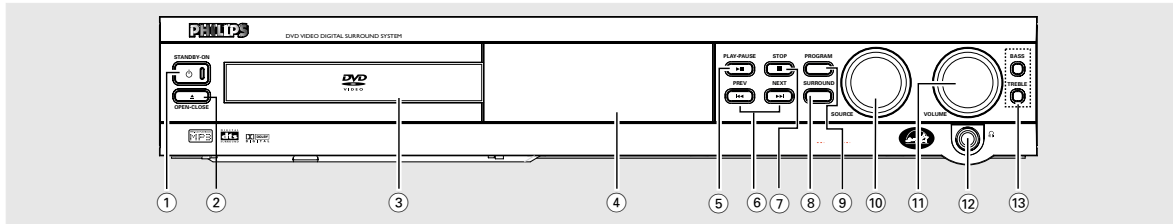

- ① **STANDBY ON**
  - to switch between power on and standby modes.
- ② **OPEN/CLOSE** (in Disc mode only)
  - to open or close the disc tray.
- ③ **Disc Tray**
- ④ **Display screen**
  - to display details for user's information.
- ⑤ **PLAY/PAUSE** (in Disc mode only)
  - to start or interrupt disc playback.
- ⑥ **PREV** / **NEXT**
  - in Disc mode, press to skip to the previous/next chapter/track.
  - in Disc mode, hold down to fast reverse/forward.
  - in Tuner mode, to tune to a lower or higher radio frequency.
- ⑦ **STOP** (in Disc mode only)
  - to stop playing the disc.
- ⑧ **SURROUND**
  - to select multichannel surround (Dolby Digital, DTS or Dolby ProLogic) or stereo sound effect.
- ⑨ **PROGRAM**
  - in Disc mode, to programme disc tracks.
  - in Tuner mode, to programme preset radio stations.
- ⑩ **SOURCE**
  - to select the desired source or external input source (TV/AV, DISC, TUNER or AUX).
- ⑪ **VOLUME**
  - to adjust the master volume.
  - to adjust the bass/treble tone level.
- ⑫
  - to connect headphones.
- ⑬ **BASS / TREBLE**
  - to select Bass/Treble adjustment mode.

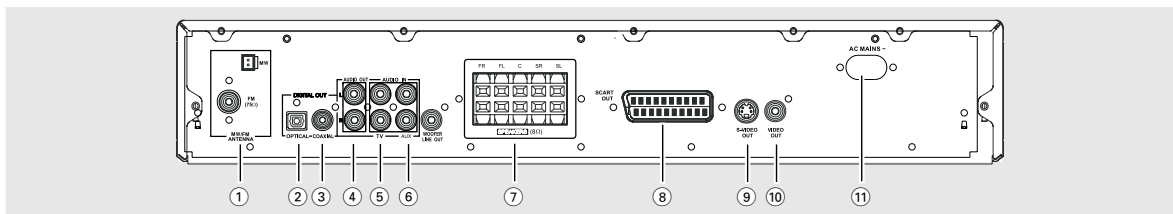

- ① **MW/FM ANTENNA**
  - connect to the MW loop antenna or FM antenna.
- ② **DIGITAL OUT-OPTICAL**
  - connect to audio equipment with digital-optical audio input.
- ③ **DIGITAL OUT-COAXIAL**
  - connect to audio equipment with digital-coaxial audio input.
- ④ **AUDIO OUT**
  - connect to the analog audio inputs of an external recording device or amplifier.
- ⑤ **AUDIO IN (TV / AUX)**
  - connect to the analog audio outputs of a TV or VCR.
- ⑥ **WOOFER LINE OUT**
  - connect to an active subwoofer.
- ⑦ **SPEAKERS**
  - connect to the front, center and surround speakers.
- ⑧ **SCART OUT**
  - connect to a TV with SCART input.
- ⑨ **S-VIDEO OUT**
  - connect to a TV with S-video input.
- ⑩ **VIDEO OUT**
  - connect to a TV with video input.
- ⑪ **AC Power Cord**
  - connect to a standard AC outlet.

**Caution: Do not touch the inner pins of the jacks on the rear panel. Electrostatic discharge may cause permanent damage to the unit.**

## Remote Control

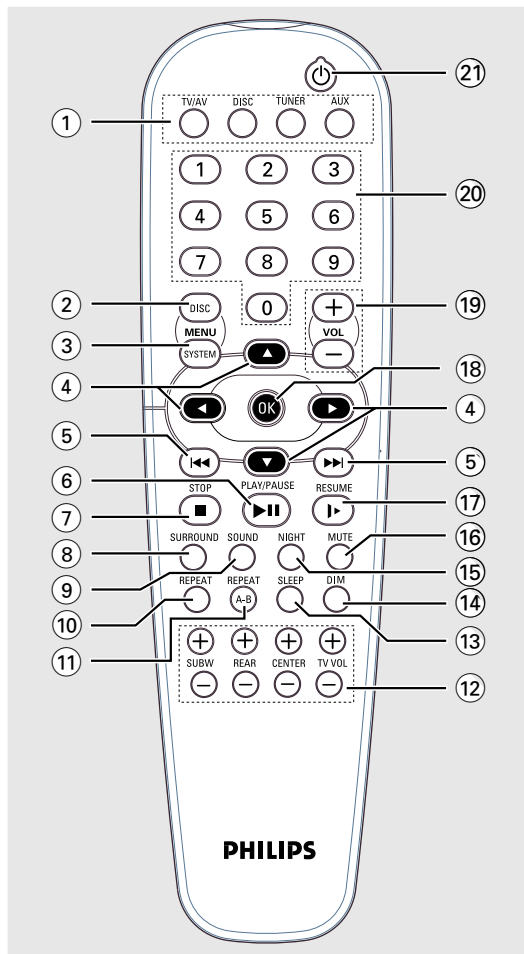

### Notes for remote control:

- First, select the source you wish to control by pressing one of the source select keys on the remote control (DISC or TUNER, for example).
- Then select the desired function (▶, ◀◀, ▶▶▶ for example).

#### ① SOURCE

- to select the desired source (TV/AV, DISC, TUNER or AUX).

#### ② DISC MENU (disc mode only)

- to enter or exit the disc contents menu.

#### ③ SYSTEM MENU (disc mode only)

- to enter or exit the system menu bar.

#### ④ ▲▼◀▶

- in Tuner mode, to select a preset radio station number (◀ or ▶).
- to select movement direction in disc contents menu / system menu bar.

#### ⑤ ◀◀ / ▶▶

- in disc mode, press to skip to the previous/next chapter/track.
- in disc mode, hold down to fast reverse/forward the disc.
- in Tuner mode, to tune to a lower or higher radio frequency.

#### ⑥ ▶||

- to start or interrupt disc playback.

#### ⑦ ■

- to stop playing the disc.

#### ⑧ SURROUND

- to select multichannel surround (Dolby Digital, DTS or Dolby ProLogic) or stereo sound effect.

#### ⑨ SOUND

- to select the various sound effects : CONCERT, DRAMA, ACTION, SCI-FI, CLASSIC, JAZZ, ROCK or DIGITAL.

#### ⑩ REPEAT

- to repeat chapter, track or disc.

#### ⑪ REPEAT A-B

- to repeat a specific section on a disc.

#### ⑫ SUBW + / –

- to adjust the subwoofer's level.

#### REAR + / –

- to adjust the rear (surround) speakers' level.

#### CENTER + / –

- to adjust the centre speaker's level.

#### TV VOL + / –

- to adjust Philips television's volume level.

#### ⑬ SLEEP

- to set the sleep (auto-off) timer function.

#### ⑭ DIM

- to select different brightness for the display screen.

#### ⑮ NIGHT (DVD mode only)

- to optimise the dynamics of the sound output.

#### ⑯ MUTE

- to interrupt or resume sound reproduction.

#### ⑰ RESUME

- to continue disc playback after an interruption.

#### ⑱ OK

- to exit or confirm the selection.

#### ⑲ VOL + / –

- to adjust the volume level.

#### ⑳ Numeric Keypad (0-9)

- to enter a track/title number of the disc.
- to enter a number of preset radio stations.

#### ㉑ ⏻

- to switch to standby mode.





# Connections

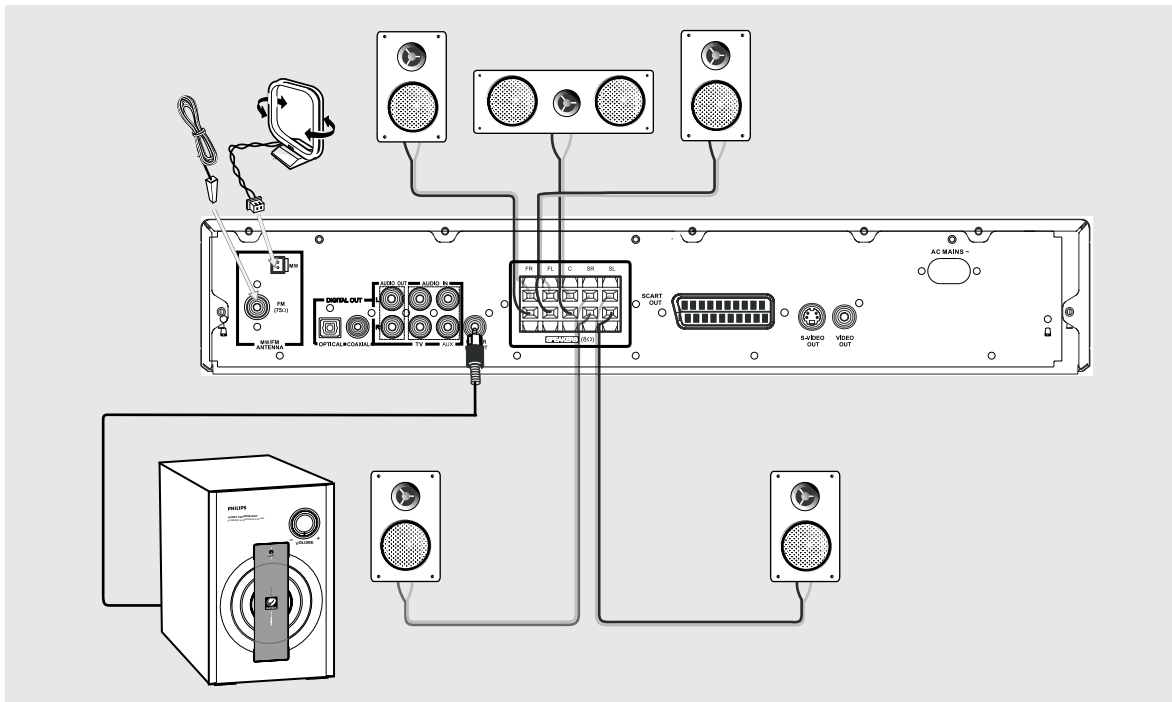

### IMPORTANT!

- Before connecting the AC power cord to the wall outlet, ensure that all other connections have been made.
- Never make or change any connections with the power switched on.
- The type plate is located at the rear or bottom of the system.

## Connecting antennas

### MW Indoor Loop Antenna

Connect the supplied MW loop antenna to the **MW** jack. Position the loop antenna to receive the clearest sound.

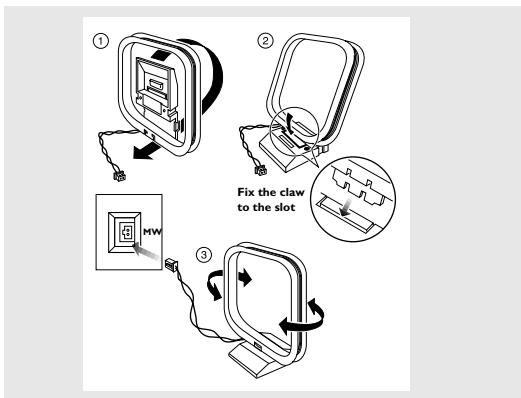

### FM Indoor Antenna

Connect the supplied FM antenna to the **FM** jack. Move the antenna in various directions until the clearest signal is received.

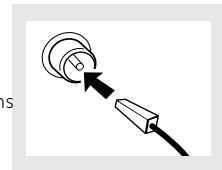

### Note:

- Keep the antenna as far away as possible from the TV, VCR or any radiation source to prevent unwanted noise.

### FM Outdoor Antenna

For better FM reception, use a 75 ohm coaxial cable (not supplied) to connect the system to an outdoor FM antenna as shown.

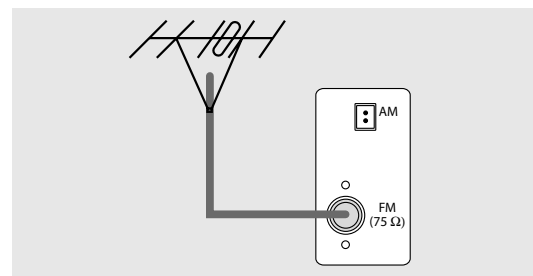

## Connecting the speakers

Connect the supplied speaker systems using the supplied speaker cables by matching the colours of the jacks and speaker cables.

- 1 Press up (or down) the speaker's jack and fully insert the stripped portion of the speaker cable into the jack, then release.

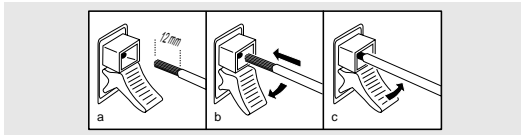

- 2 Connect the subwoofer's audio input to the **WOOFER LINE OUT** jack and the speakers as follows :

Speakers	⊖	⊕
Front Left (FL)	black	white
Front Right (FR)	black	red
Centre (C)	black	green
Surround Left (SL)	black	blue
Surround Right (SR)	black	grey

### Notes:

- Ensure that the speaker cables are correctly connected. Improper connections may damage the system due to short-circuit.
- For optimal sound performance, use the supplied speakers.
- Do not connect more than one speaker to any one pair of + / - speaker jacks.
- Do not connect speakers with an impedance lower than the speakers supplied. Please refer to the SPECIFICATIONS section of this manual.

## Connecting a TV and additional components

You must connect a TV to the DVD system in order to use the DVD player. You can connect other audio and audio/visual components to the DVD system in order to use the Home Cinema Audio System's surround sound capabilities.

### IMPORTANT!

- There are various ways to connect the system to a TV (as shown in the illustration). You only need to make one of the best connections, depending on the capabilities of your TV system.
- Always refer to the instruction manual of the connected equipment to make an optimal connection.
- Some DVD discs have anti-copying devices, so you will not be able to record the disc through a VCR.

- Use the supplied audio cables to connect **AUDIO IN** jacks to the corresponding AUDIO OUT jacks on the TV, VCR or other audio/visual components.
- Use the supplied Scart cable to connect **SCART OUT** jack to the corresponding SCART VIDEO IN jack on a TV.

If your TV is not equipped with a Euroconnector, you can select one of the following alternative connections :

### Option 1

Connect the **S-VIDEO OUT** jack to the S-Video input jack on the TV using a S-Video cable (not supplied) .

### Option 2

Connect the **VIDEO OUT** jack to the video input jack on the TV using a video cable (not supplied).

### Use the AUDIO OUT jacks

- for connecting to an amplifier, audio system or TV with analogue audio inputs.
- for connecting to a CD or Tape recorder to make an analogue recording.

### Use the OPTICAL or COAXIAL jacks

- for connecting to an amplifier with DTS, Dolby Digital decoder or CD recorder.
- You will need to set the DVD system's digital output to "ALL" (refer to "Preparations - System setup (DVD)").

### Notes:

- MP3 audio is not available on the digital output.
- Digital recording is only possible on a CD or VCD.

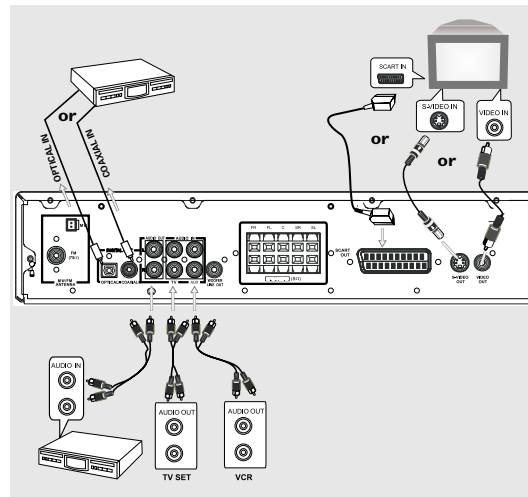



## Preparations

### Inserting batteries into the remote control

- 1 Open the battery compartment.
- 2 Place the batteries in the compartment with the correct polarity as indicated by "+" and "-" symbols.
- 3 Close the cover.

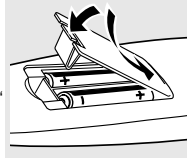

#### CAUTION!

- Remove batteries if they are exhausted or will not be used for a long time.
- Do not use old and new or different types of batteries in combination.
- Batteries contain chemical substances, so they should be disposed off properly.

### Switching on the system

- 1 After completing all the connections, connect the AC power cord of the player and subwoofer to the power outlet.
  - 2 Press **STANDBY ON** to switch on the last selected source.
  - 3 Adjust the **SOURCE** button (or press **TV/AV, DISC, TUNER** or **AUX**) to select the input source.
    - The selected source will be displayed.
- For viewing a DVD or VCD disc, a TV set needs to be connected (refer to "Connections - Connecting a TV and additional components"). Switch on the TV and set to the correct video in channel (for example, EXT1, EXT2, AV1, AV2). Refer to your TV instruction manual for details.
    - The default screen appears on the TV.
  - You can connect other external components to the DVD system in order to use the Home Cinema Audio System's surround sound capabilities. For example, connect to a TV and select TV/AV as the input source or connect to a VCR and select AUX as the input source.

### Setting up the surround sound system

You must connect all the speakers and set up the system properly in order to enjoy the Digital Cinema experience at home (refer to "Connections - Connecting the speakers"). You will have the feeling of being in the middle of the action because sound is coming from everywhere around you. The subwoofer can enhance the bass performance of your system dramatically.

#### IMPORTANT!

**Please sit at your usual listening position in order to set up the speaker balance correctly.**

#### Placing the speakers

To obtain the best surround effect, place the speakers as follows.

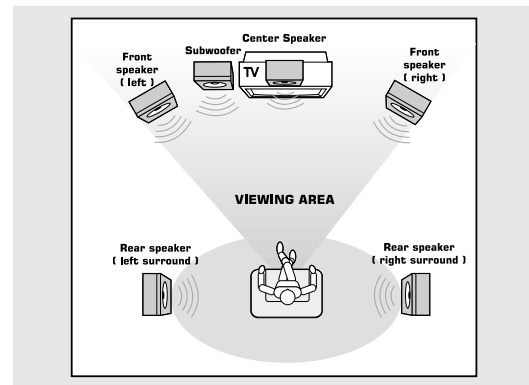

- 1 Place the front left and right speakers at equal distances from the TV and at an angle of approximately 45 degrees from the listening position.
- 2 Place the centre speaker above or below the TV so the centre channel's sound is localised.
- 3 Place the surround speakers at normal listening ear level facing each other or mounted on the wall.
- 4 Place the subwoofer on the floor near the TV.

#### Notes:

- To avoid magnetic interference, do not position the front speakers too close to your TV.
- If the rear surround speakers are installed farther away from the listening position than the front and centre speakers, it will weaken the surround effect.
- All speakers should be securely installed to prevent accidents and improve sound quality.

### Changing the volume level

You can change the speakers' sound distribution to suit your surround sound needs.

- Press **CENTER** +/- to adjust the level of the centre speaker:  
→ "CENT +xx dB" is displayed.
- Press **REAR** +/- to adjust the level of the rear surround speakers.  
→ "RE +xx dB" is displayed.

#### Note:

– "xx" denotes the volume level between -15dB to 10dB.

### Setting up the subwoofer

- 1 Use the supplied subwoofer cable to connect the subwoofer's audio input jack to the **WOOFER LINE OUT** of the DVD system.
- 2 Connect the subwoofer's AC power cable to the wall socket and switch on the power:  
→ It will automatically switch on when receiving an audio signal input. If there is no audio signal input, it will switch off automatically.
- 3 Select the phase polarity at the rear of the subwoofer at either **0°** or **180°** to determine better bass reproduction effect in certain listening environment.
- 4 Press **SUBW** +/- to adjust the volume level of the subwoofer (-15dB to 10dB).  
→ "SUB +xx dB" is displayed.

### System Setup (DVD)

The system setup is carried out via the TV, enabling you to customise the DVD system to suit your particular requirement. If the preferred options selected are not available on a disc, then the disc's own preference will be used.

#### IMPORTANT !

**To access the System Setup menu, playback must be stopped.**

#### General operation

- 1 Press **SYSTEM MENU**.  
→  icon will be highlighted in the menu bar on the TV screen.
- 2 Press **▼** to activate the System Setup menu.
- 3 Use **◀▶▲▼** keys to toggle through the functions and select your preferred option.
- 4 Press **OK** to confirm a highlighted selection.
- 5 To exit the System Setup menu, press **SYSTEM MENU** or **OK**.

The following items are available :

#### Setting the picture



#### – TV Shape

Select the aspect ratio of the TV to be connected.

##### **4:3 PS** (default setting)

– If you have a conventional TV set and your DVD is not formatted for widescreen viewing, use this setting. A wide picture is displayed on the whole TV screen with a portion automatically cut off.

##### **4:3 LB**

– If you have a conventional TV set and your DVD is formatted for widescreen viewing, use this setting. Wide bands will be displayed on the upper and lower portions of the TV screen.

##### **16:9**

– If you have a widescreen TV set, use this setting (you must also set your widescreen TV to "full size").

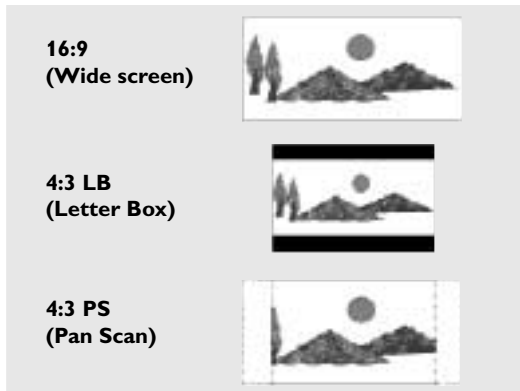
**Note:**

– If your DVD is not encoded to allow you to change the aspect ratio, TV shape cannot be changed.

**– TV System**

Allows you to select the colour system matching the connected TV set.

**AUTO** (default setting)

– If the connected TV is multi system, select this mode. The output format will be in accordance with the video signal of the disc.

**NTSC**

– If the connected TV is NTSC system, select this mode. It will change the video signal of a PAL disc and output in NTSC format.

**PAL**

– If the connected TV is PAL system, select this mode. It will change the video signal of a NTSC disc and output in PAL format.

**– Video Out**

Video out selection enables you to choose the type of video output suitable for your receiver.

- Select **SCART** (default setting), if you have connected the video output to your TV using the Scart jack.
- **PR PB Y** (this feature is not available for this model)
- Select **S-VIDEO** if you have connected the video output to your TV using S-Video jack.

**– Screen Saver**

If set to ON, when you leave the system in stop or pause mode for more than one minute, the screen saver will be activated. The default setting is OFF.

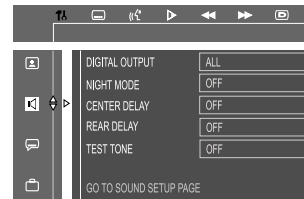
**Setting the sound****– Digital Output**

Digital output selection enables you to specify the type of digital output suitable for your amplifier or receiver.

- Select **ALL** (default setting), if you have connected the digital output (COAXIAL or OPTICAL) to a multichannel decoder receiver.
- Select **PCM 96K** if the external component is capable of processing digital signal input with sampling rates of 96 kHz.
- Select **PCM 48K** if the external component is incapable of processing 96 kHz digital signal input, then convert to standard signal with sampling rates of 48 kHz.
- Select **OFF** to deactivate the digital output (COAXIAL or OPTICAL).

**– Night Mode**

Set night mode to on to level out the volume. For example, the disc will play at the same sound level throughout the movie. The default setting is OFF.

**Night function can also be accessed via the remote control.**

**– Center Delay**

If the listening position is closer to the centre speaker than the front speakers, you can set the center delay time to improve the surround sound effect.

Options : 5ms, 3ms, 2ms, 1ms or OFF (default setting).

**– Rear Delay**

If the listening position is closer to the rear surround speakers than the front speakers, you can set the rear delay time to improve the surround sound effect.

Options : 15ms, 12ms, 9ms, 6ms (default setting), 3ms or OFF.

**– Test Tone (disc mode only)**

If set to ON, the system will test the speaker settings. The test signal is generated through the left, centre, right, and surround speakers. The default setting is OFF.

## Setting the language



- Audio
- Subtitle
- Disc Menu

- This is to select the audio language, subtitle language and the language used on TV screen menus or DVD menus that will always be used for every disc to be played back. The default setting is English.
- If the language selected is not available on the disc, the original language designated by each disc will be selected.

## Setting the features



### - Parental

Enables setting of playback limitation level. Some DVDs may have a parental level assigned to the complete disc or to certain scenes on the disc. The rating levels are from 1 to 8 and are country dependent. You can prohibit the playing of certain discs that are not suitable for your children or have certain discs played with alternative scenes.

- 1 Enter the 4-digit code. If necessary, enter the code a second time.

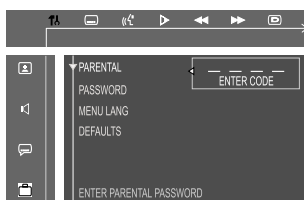

- 2 Use ▲▼ keys to select a rating level.

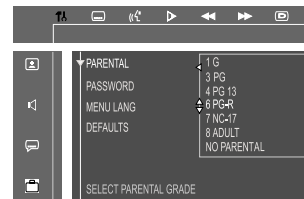

- 3 Press **OK** to confirm.

### Rating - NO PARENT

If parental control is not activated, it will play all discs.

### Rating - 1 to 8

If the player's parental level is set below 8, only discs with a lower or equal level will play. For example, if the player is set to 5, only discs with ratings of 5, 4, 3, 2 and 1 will be played. Higher rated scenes will not be played unless an alternative that has the same rating or lower is available on the disc. For example, consider a disc that generally is suitable for most audiences, and it is rated at level 2 for the most part. However, in the middle, there are also scenes rated at 5 (not suitable for children).

### To play a higher rated disc or scene than the level set

- Enter the 4-digit cord before resetting the rating level to a higher number (go to "Password").

### If you forget the 4-digit code

- 1 Press **■** four times when prompted for the password and the system will change back to the default password.
- 2 Go to "Password" and enter your new code.

### Note:

– Some DVDs are not encoded with a rating though the movie rating is printed on the disc jacket. The rating level feature does not work for such discs.

### - Password

To set a new password for the parental control or to change the password. The password supplied as default is 1234.

### - Menu Language

Select the language for on screen display.

### - Defaults

If RESET is selected, all the items in the setup menu will be reset to default setting.



## Basic Functions

### Selecting the surround sound mode

#### IMPORTANT!

- For proper surround sound, make sure you have followed the “Connections” and “Preparations” procedures fully.
  - The centre and surround speakers only operate when the system is set to surround sound mode and the source material being played is recorded or broadcast in Dolby Digital, DTS or Dolby Pro Logic surround sound.
  - Stereo broadcasts or recordings will produce some surround channel effects when played in a surround mode. However, mono sources will not produce any sound from the surround speakers.
- Press **SURROUND** to select surround or stereo mode.
    - The availability of the various surround sound modes depend on the number of speakers used and the incoming sound information available on the disc. The available output modes are shown below.

#### Dolby Digital Surround

Dolby Digital (also known as AC-3 or Dolby 5.1) and MPEG Multichannel delivers a realistic and dynamic sound similar to theatre and cinema. It requires connection of all five speakers (front left/right, centre, surround left/right) and subwoofer for correct Dolby Digital Surround sound reproduction. Each channel plays its own unique role in providing the right sound. Front left, centre and right join two surround speakers to reproduce high, mid and bass frequencies in five full-range channels of surround. Bass rumble, explosions and low frequency effects you feel are delivered through the subwoofer. A large number of DVD discs have been recorded in Dolby Digital Surround.

#### DTS Surround

The DTS Surround is a cinema surround sound format that offers superior digital audio performance. DTS offers more clarity and definition especially for higher tones. The better sound quality is a result of the limited sound compression (3:1 instead of 11:1 for Dolby Digital) and the 20-bit resolution.

#### Dolby Pro Logic Surround

The Dolby Pro Logic Surround system is a specially encoded two-channel analogue format that will produce sound through four speaker channels (front left, centre, front right, mono surround) when a Dolby Pro Logic Decoder is used. It is also compatible with stereo systems but the user will only have two-channel (front left & right) of sound.

#### Matrix

A new surround playback system that delivers amazingly rich and convincing five-channel surround outputs (front left/right, centre, surround left/right).

#### VSS (Virtual Surround Sound)

The ProLogic MPEG or Dolby Digital surround channel is processed by a 'virtualiser' DSP to add surround effect from just the two front speakers.

#### Stereo

All sound is reproduced and played through the front left and right speakers. This enables standard stereo reproduction.

### Selecting the digital sound effect

The digital sound effects allow you to select from various pre-set modes that control the frequency bands of sound to optimise certain musical styles. It greatly enhances the excitement and enjoyment of your favourite music.

- Press **SOUND** repeatedly to select the available sound effect.

#### When playing a DVD/VCD, select :

- CONCERT, DRAMA, ACTION or SCI-FI

#### When playing a CD or in Tuner or Aux mode, select :

- CLASSIC, JAZZ, ROCK or DIGITAL

## Volume control

Adjust **VOLUME** button (or press **VOL + / -**) to increase or decrease the volume level.

→ "VOL XX" is displayed. "XX" denotes the volume level.

### For Philips TVs only

- Press **TVVOL + / -** on the remote control to adjust the TV's volume level.

### To listen through the headphones

- Connect the headphones plug to the  socket at the front of the player.  
→ The speakers will be muted.

### To switch off the volume temporarily

- Press **MUTE**.  
→ Playback will continue without sound and "MUTE" is displayed.
- To restore the volume, press **MUTE** again.

## Adjusting the tone

The **BASS** (low tone) and **TREBLE** (high tone) feature enables you to define the sound-processor settings.

- 1 Press **BASS** or **TREBLE** on the system to select Bass or Treble sound feature.
- 2 While in Bass or Treble adjustment mode, adjust **VOLUME** knob to select the desired Bass or Treble level.

### Notes:

- The volume knob can be used to adjust Bass/Treble level immediately after you have selected the respective Bass/Treble sound feature. If the volume knob is not used within 5 seconds, it will become normal volume control function.
- If no button is pressed within a few seconds, the player will exit the tone mode automatically.

## Dimming the display screen

- Press **DIM** repeatedly to select different levels of brightness for the display screen : HIGH, MID or LOW.





# Operations

English

## Discs information

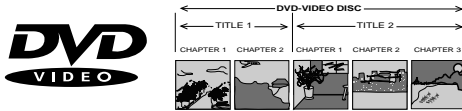

- DVD video discs may have one or more Titles, and each Title may have one or more Chapters.
- Playback stops at the end of each Title.

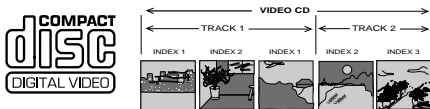

- Video CDs may have one or more Tracks, and each Track may have one or more Indexes.
- To make easy and convenient access, you can move between Tracks and Indexes.
- Some Video CDs have Play Back Control (PBC), which is a predefined playback sequence stored on the disc (refer to "Special VCD/SVCD features").

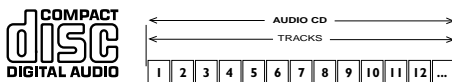

- Audio CDs contain only Tracks.

## Basic playback

### CAUTION!

- Do not move the disc player during playback, as doing so may damage the DVD system.
- Do not push on the disc tray or put any objects other than disc on the disc tray. Doing so may cause the disc player malfunction.

- 1 Press **STANDBY ON** or **POWER** to switch the system on.
- 2 Press **OPEN/CLOSE** to open the disc tray.
- 3 Load a disc with the label side facing up.
- 4 Press **OPEN/CLOSE** again to close the tray.
  - There will be a short delay while the player identifies the disc and reads the menu from the disc.
- Some discs will start playing automatically, and others will display the Disc Contents Menu on the TV screen. If the menu is presented, use **▲▼◀▶** keys to highlight your selection and press **OK** to confirm. To select a play option, press **numeric keypad (0-9)**.
- 5 Press **▶||** to start playback.

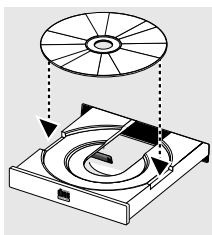

### Notes:

- Your player will not play discs that have a region code different from the region code of your player.
- If the inhibit icon appears on the TV screen when a button is pressed, it means the function is not available on the disc you are playing.

### To interrupt playback

- Press **▶||**
  - The picture freezes and the sound will be muted.
- To resume playback, press **▶||** again.

### To stop playback

- Press **■**.

### Skipping to another track/chapter

- Press **◀◀** or **▶▶** repeatedly during playback to skip backward or forward. Each press will take the disc to the beginning of the previous or next track/chapter.

### Note:

- If the REPEAT function has been set, pressing **◀◀** or **▶▶** will replay the same track/chapter.

### To skip to the beginning of the current track/chapter during playback

- Press **◀◀** once.

### To go directly to any track/chapter

- Use the **numeric keypad (0-9)** to enter the number of the desired track/chapter.

### Fast Search

- 1 Hold down **◀◀** or **▶▶** about **two seconds** to fast reverse or forward the disc.
- 2 To resume normal play, press **▶||**.

### Continue playback from the last stop point

- In stop mode and when a disc has not been ejected, press **RESUME** to resume playback from the point at which it stopped.

### To cancel the resume mode

- Press **■** again.

### Notes:

- When the player is disconnected from the power supply or the disc tray is opened, the resume option will be cancelled automatically.
- The resume option may not be available on some discs.

### Repeat play

You can only select the repeat play mode during playback.

#### For DVD - Repeat chapter/title/disc

- Press **REPEAT** repeatedly to select the following :
  - "R- I" – repeat chapter.
  - "R- R" – repeat title/disc.

#### For VCD/CD/MP3-CD - Repeat track/disc

- Press **REPEAT** repeatedly to select the following :
  - "R- I" – repeat the current track.
  - "R- R" – repeat the entire disc.

#### Notes:

- Repeat play might not work correctly with some DVDs.
- For VCD, repeat play is not possible during PBC playback.

### Repeat A-B

You can play a specific section in a chapter/track repeatedly.

- 1 Press **REPEAT A-B** at your chosen starting point.
- 2 Press **REPEAT A-B** again at your chosen end point.
  - The passage will now repeat continuously.
- 3 To resume normal play, press **REPEAT A-B** again.

#### Note:

- The section A and B can be set only within the same chapter/track.

### Programme favourite tracks

You can play the contents of the disc in the order you want by programming the order of the tracks to be played. Up to 99 tracks can be stored.

- 1 While playback is stopped, select or press **PROGRAM** to enter programme mode.
  - "P 00:00" is displayed.
- 2 Use the **numeric keypad (0-9)** to input the track number in the order you want.
  - If you attempt to programme more than 99 tracks, "FULL" is displayed.
- 3 Press **OK** to store the track.
- Repeat **steps 2-3** to store other tracks.
- 4 To start programme play, press **▶II**.
- 5 To stop playback, press **■ once**.
- 6 To cancel the programme, press **■** again.

#### Programme function can also be accessed via the menu bar

- 1 Press **SYSTEM MENU** and select  from the menu bar.
- 2 Repeat **steps 2-6** listed above to programme your favourite tracks.

### Special DVD/VCD features

A number of operations can be carried out directly via the multiple menu bars on the TV screen without interrupting disc playback.



From the left,

SETUP MENU → SUBTITLE → LANGUAGE → SLOW  
→ FAST REVERSE → FAST FORWARD → STATUS



From the left,

TITLE SEARCH → CHAPTER SEARCH → TIME  
SEARCH → ZOOM → ANGLE → STEP →  
PBC ON/OFF



From the left,

PROGRAM

#### IMPORTANT!

**Some operations may be different or restricted, depending on the disc format. Refer to the jacket or case of the disc you are playing.**

- 1 Press **SYSTEM MENU**.
  - The menu bar will be displayed across the top of the TV screen.
- 2 Press **◀** or **▶** to move through the menu bar.
- 3 Press **▼** to select the highlighted icon and use **▲▼** keys to select your preferred option.
- 4 Press **OK** to confirm a highlighted selection.
- 5 To exit, press **SYSTEM MENU** or **OK**.

#### Changing subtitle language

This operation works only on DVDs with multiple subtitle languages.

- Select  from the menu bar and press **▼** key to select the desired language.



### Changing sound track language

This operation works only on DVDs with multiple soundtrack language.

- Select from the menu bar and press ▼ key to select the desired language.

#### For VCD :

- Press ▼ key to select the desired audio channels for sound :  
LEFT VOCAL → RIGHT VOCAL → MONO LEFT  
→ MONO RIGHT → STEREO → LEFT VOCAL

#### Note:

– When the desired language is not selected even after pressing the button several times, it means the language is not available on the disc.

### Playing in slow motion mode

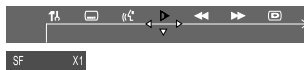

- 1 Select from the menu bar and press ▼ key to select the required slow motion speed :  
SF x2 → SF x4 → SF x8 → SR x2 → SR x4 → SR x8 → SLOW OFF  
(SF) = slow forward  
(SR) = slow reverse

#### For VCD :

- 1 Press ▼ key to select the required slow motion speed :  
(forward) : SF x1 → SF x2 → SF x3 → OFF
- 2 To resume normal play, press ►►

#### Note:

– The sound will be muted during slow-motion play.

### Searching for a particular passage



- 1 Select or from the menu bar to select fast reverse search or fast forward search respectively.
- 2 Press ▼ key to select the required search speed :  
(reverse) : FR x2 → FR x4 → FR x6 → FR x8 → OFF  
(forward) : FF x2 → FF x4 → FF x6 → FF x8 → OFF

#### For VCD :

- 2 Press ▼ key to select the required search speed :  
(reverse) : FR x1 → FR x2 → FR x3 → FR x4 → OFF  
(forward) : FF x1 → FF x2 → FF x3 → FF x4 → OFF

- 3 To resume normal play, press ►►

#### Note:

– The sound will be muted during fast reverse or forward search.

### Display the disc information during playback

- Select from the menu bar and press ▼ key to select the following display informations :

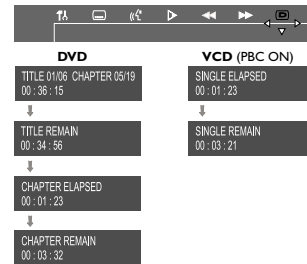

### Moving to another title/chapter

Some discs may contain more than one title or chapter. If the disc has a title or chapter menu recorded on it, you can start playback from the selected item.

- 1 Select **T** (title) or **C** (chapter) from the menu bar.
- 2 Use **numeric keypad (0-9)** to select a desired title/ chapter number and press **OK** to start playback.

#### Note:

– Selecting a title or chapter might not be possible on certain discs.

### Playback from a selected point

This function allows you to start playing at any chosen time on the disc.



- 1 Select from the menu bar.
- 2 Enter hours, minutes and seconds from left to right in the time edit box using the **numeric keypad (0-9)**.  
→ Each time an item has been entered, the next item will be highlighted.
- 3 Press ►► to start playback.



### Zooming in

This function allows you to enlarge the picture on the TV screen and to pan through the enlarged image.

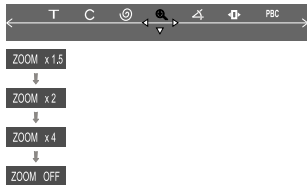

- 1 Select from the menu bar and press **▼** key repeatedly to select a zoom factor : x1.5 → x2.0 → x4.0 → OFF.
- 2 To pan through the enlarged image, press **OK** to confirm the zoom selection and use **◀▶▲▼** keys to move the zoomed picture left, right, up and down.
- 3 To exit ZOOM mode, select zoom factor to "ZOOM OFF" from the menu bar.

### Viewing from another angle

If the disc contains sequences recorded from different camera angles, this allows you to view the picture from different angles. The selections of angle are depending on the disc format.

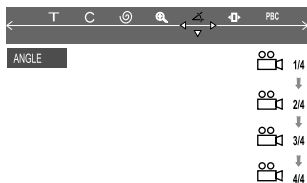

- Select from the menu bar and press **▲▼** keys to select the desired angle : 1/4, 2/4, 3/4 or 4/4.  
→ Playback changes to the selected angle.

### Advancing by frames



- 1 Select from the menu bar and press **▼** key to play the disc step by step (one frame each step).
- 2 To resume normal play, press **▶||**.

### Checking the contents of DVD

- 1 Press **DISC MENU** on the remote control.  
→ If the current title has a menu, the menu will appear on the screen. Otherwise, the disc menu will be displayed.
- 2 Use **◀▶▲▼** keys to select the desired title or chapter, followed by **▶||** or **OK**.  
→ The selected title or chapter starts playing.

#### Notes:

- The details of operation might differ depending on the DVD disc.
- Selecting a title or disc might not be possible on certain DVD discs.

## Special VCD/SVCD features

### Playback Control (PBC)

PBC playback allows you to play Video CDs interactively, following the menu on the display.

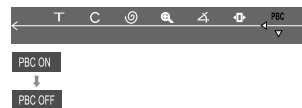

- Select in the menu bar and press **▼** key to select PBC ON or PBC OFF.

### When playing a disc with PBC function

- If "PBC OFF", the system will start playback automatically.
- If "PBC ON", the PBC menu (if available) will appear on the TV screen for selection. Use the **numeric keypad (0-9)** to enter your choice.

#### Note:

- If PBC mode is switched on, TIME SEARCH and REPEAT functions are not available.



## Special MP3-CD features

- JPEG format
- Max. 12 characters
- Max. nested directory is 7 levels
- The max. album number is 32
- Supported VBR bit-rate
- Supported sampling frequencies for MP3 disc are :  
32 kHz, 44.1 kHz, 48 kHz
- Supported Bit-rates of MP3 disc are: 32, 64, 96, 128,  
192, 256 (kbps)
- The disc reading time may exceed 30 seconds due to  
the large number of songs compiled onto one disc.

### MP3-CD menu

- 1 Press **DISC MENU** to switch on the MP3-CD menu.  
→ The album menu appears on the TV screen.
  - 2 To select a desired album, press **▲▼◀▶** and followed by  
**OK** or **▶||** to confirm.  
→ The title menu appears on the TV screen.
  - 3 To select a desired title, press **▲▼◀▶** and followed by **OK**  
or **▶||** to start playback.
- You can also use the **numeric keypad (0-9)** to enter  
your choice.

### If the MP3-CD menu is switched off

- You can only play the existing selected title by pressing  
**▶||** button. While in playback mode, press **◀◀/▶▶** to  
select the previous/next title.  
→ The title number will be displayed.

Only the following functions are possible for MP3 disc.

- STOP / PLAY / PAUSE / OK
- REPEAT (TITLE/ALBUM/DISC)

## Other Functions

### Tuning to radio stations

- 1 Press **STANDBY ON** to switch on the last selected source.
- 2 Adjust **SOURCE** (or press **TUNER**) to select TUNER mode.
- 3 Press **TUNER** again to select the desired band : FM, MW or LW.
- 4 Press and hold **◀◀** or **▶▶** until the frequency indication starts to change, then release.  
→ The system automatically tunes to the next strong radio station.

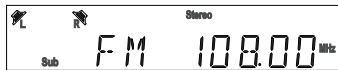

- To tune to a weak station, press **◀◀** or **▶▶** briefly and repeatedly until an optimal reception is found.
- 5 Repeat **step 4** if necessary until you find the desired radio station.

### Presetting radio stations

You can preset up to 40 stations regardless of the reception.

- 1 Tune to your desired radio station (refer to "Tuning to radio stations").
- 2 Press **PROGRAM**.  
→ "Program" appears.



- 3 Use the **numeric keypad (0-9)** to select the desired preset number.

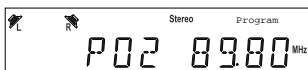

Note:

– If "Program" icon goes off before you select the desired preset number, press **PROGRAM** again.

- 4 Press **PROGRAM** again to store the radio station.
- Repeat **steps 1–4** to store other radio stations.

Notes:

– If you attempt to programme more than 40 preset radio stations, "FULL" is displayed.

– During programming, if no key is pressed within five seconds, the system will exit the programme mode automatically.

### Listening to preset radio stations

- In tuner mode, press **◀** or **▶** or use the **numeric keypad (0-9)** to select the desired preset number.  
→ The preset number, radio frequency, and waveband are displayed.

### Sleep timer setting

The sleep timer enables the system to switch to standby mode automatically at a preset time.

- 1 Press **SLEEP** repeatedly to select a preset time.  
→ The selections are as follows (time in minutes):  
15 → 30 → 45 → 60 → 90 → 120 → OFF → 15...



- 2 When you reach the desired length of time, stop pressing the **SLEEP** button.  
→ "Sleep" icon appears.

#### To check the remaining length of time after sleep timer is activated

- Press **SLEEP once**.

#### To change the preset sleep timer

- Press **SLEEP** again while the remaining sleep timer is shown.  
→ The display will show the next sleep timer options.

#### To deactivate the sleep timer

- Press **SLEEP** repeatedly until "OFF" is displayed, or press the **STANDBY ON** button.



# Specifications

English

## AMPLIFIER SECTION

Output power	
- Stereo mode (DIN)	2 x 50 W
- Surround mode (1 kHz)	50 W RMS/channel
Total Harmonic Distortion	10% at rated power (1 kHz)
Frequency Response	180 Hz – 14 kHz / ±1 dB
Signal-to-Noise Ratio	> 65 dB (CCIR)
Input Sensitivity	400 mV

## TUNER SECTION

Tuning Range	FM 87.5 – 108 MHz (50 kHz steps)
	MW 531 – 1602 kHz (9 kHz steps)
26 dB Quieting Sensitivity	FM 20 dB
26 dB Quieting Sensitivity	MW 5000 µV/m
Image Rejection Ratio	FM 25 dB
	MW 28 dB
IF Rejection Ratio	FM 60 dB
	MW 24 dB
Signal-to-Noise Ratio	FM 55 dB
	MW 35 dB
AM Suppression Ratio	FM 30 dB
Harmonic Distortion	FM Mono 3%
	FM Stereo 3%
	MW 5%
Frequency Response	FM 180 Hz – 10 kHz / ±6 dB
Stereo Separation	FM 26 dB (1 kHz)
Stereo Threshold	FM 23.5 dB

## DVD SECTION

Laser Type	Semiconductor
Disc Diameter	12cm / 8cm
Video Decoding	MPEG-2
Video DAC	10 Bits
Signal System	PAL / NTSC
Video Format	4:3 / 16:9
Video S/N	56 dB (minimum)
Composite Video Output	1.0Vp-p, 75 Ω
S-Video Output	Y - 1.0Vp-p, 75 Ω
	C - 0.286Vp-p, 75 Ω
Audio DAC	Direct Digital Amplification
Frequency Response	4 Hz – 20 kHz (44.1 kHz)
	4 Hz – 22 kHz (48 kHz)
	4 Hz – 44 kHz (96 kHz)
Digital Output	SPDIF Coaxial & Optical

## MISCELLANEOUS

Power Supply Rating	220 – 240 V / 50 Hz
Power Consumption	250 W
Dimensions (w x h x d)	435 mm x 81 mm x 360 mm
Weight	7.1 kg

## IR REMOTE CONTROL

Effective Range	> 8 Meter
Number of Keys	45
Battery (1.5V)	AA x 2

## SPEAKERS

### Front speakers / Rear (surround) speaker

System	2-way shielded
Impedance	8 Ω
Speaker drivers	3" full range, 1" piezo
Dimensions (w x h x d)	96 mm x 155 mm x 95 mm
Weight	0.45 kg/each

### Centre speaker

System	2-way shielded
Impedance	8 Ω
Speaker drivers	2 x 3" full range, 1" piezo
Dimensions (w x h x d)	250 mm x 94 mm x 88 mm
Weight	0.92 kg

## SUBWOOFER

Subwoofer (not magnetically shielded design)	6.5"
Output power	100 W (4 Ω, DIN)
THD	10% at 55 Hz
Reproduction frequency response	30 Hz – 140 Hz
Phase switch	0°, 180°
Input sensitivity (Subwoofer In)	200 mVrms
AC power	220 – 240 V / 50 Hz
Power Consumption	66 W (at 1/8 Rated Power)
Dimensions (w x h x d)	200 mm x 310 mm x 370 mm
Weight	6.8 kg

Specifications subject to change without prior notice



# Troubleshooting

English

## WARNING!

Under no circumstances should you try to repair the system yourself, as this will invalidate the warranty. Do not open the system as there is a risk of electric shock.

If a fault occurs, first check the points listed below before taking the system for repair. If you are unable to solve a problem by following these hints, consult your dealer or service centre.

Problem	Solution
<b>No power.</b>	<ul style="list-style-type: none"> <li>– Check if the AC power cord is properly connected.</li> </ul>
<b>No picture.</b>	<ul style="list-style-type: none"> <li>– Select the appropriate video input mode on the TV.</li> <li>– Check if the TV is switched on.</li> <li>– Check the video connection.</li> </ul>
<b>Distorted or poor picture.</b>	<ul style="list-style-type: none"> <li>– Sometimes a small amount of picture distortion may appear. This is not a malfunction.</li> <li>– Clean the disc.</li> <li>– Connect the system to TV's S-video input.</li> </ul>
<b>Completely distorted picture or black/white picture.</b>	<ul style="list-style-type: none"> <li>– Make sure the NTSC/PAL setting at the DVD player matches the video signal of your television (see "System Setup (DVD) - Setting the pictures - TV system").</li> </ul>
<b>The aspect ratio of the screen cannot be changed even though you have set the TV shape.</b>	<ul style="list-style-type: none"> <li>– The aspect ratio is fixed on the DVD disc.</li> <li>– Depending on the TV, it may not allow you to change the aspect ratio.</li> </ul>
<b>No sound or distorted sound.</b>	<ul style="list-style-type: none"> <li>– Adjust the volume.</li> <li>– Check that the speakers are connected correctly.</li> <li>– Replace the speaker cables.</li> <li>– Check the speaker settings.</li> <li>– The system is in pause, slow motion or fast forward/reverse mode, press PLAY to resume normal play mode.</li> </ul>
<b>No sound is heard from the centre or rear speakers.</b>	<ul style="list-style-type: none"> <li>– Use the CENTER +/– or REAR +/– to adjust the volume level.</li> <li>– Check that the centre or rear surround speakers are connected correctly.</li> <li>– Use surround mode.</li> </ul>
<b>The DVD player does not start playback.</b>	<ul style="list-style-type: none"> <li>– Insert a readable disc with the playback side facing down.</li> <li>– Check the disc type, color system and regional code. Check for any scratches or smudges on the disc.</li> <li>– Press SYSTEM MENU to turn off the setup menu screen.</li> <li>– Cancel the parental control rating function or change the rating level.</li> <li>– Moisture has condensed inside the system. Remove the disc and leave the system turned on for about an hour.</li> </ul>
<b>The DVD system does not respond when the buttons are pressed.</b>	<ul style="list-style-type: none"> <li>– Disconnect the power plug from the outlet and insert again.</li> </ul>
<b>The language for the sound or subtitle cannot be changed when playing a DVD.</b>	<ul style="list-style-type: none"> <li>– Multi-language sound or subtitle is not recorded on the DVD.</li> <li>– Changing the language for the sound or subtitle is prohibited on the DVD.</li> </ul>
<b>No image is output when a function is selected.</b>	<ul style="list-style-type: none"> <li>– Make sure the component is connected correctly.</li> <li>– Press the correct function button for the input source.</li> </ul>
<b>Considerable noise in radio broadcasts.</b>	<ul style="list-style-type: none"> <li>– Tune in the correct frequency.</li> <li>– Connect the antenna.</li> <li>– Route RF (AC-3) and digital cables away from the antenna terminals and wires.</li> <li>– Fully extend the FM wire antenna. Position for best reception and secure to a wall.</li> <li>– Connect an outdoor FM or MW antenna.</li> <li>– Adjust the direction and position for best reception.</li> <li>– Turn off the equipment causing the noise or move it away from the DVD system.</li> <li>– Place the antenna farther away from the equipment causing the noise.</li> </ul>
<b>The remote control does not function.</b>	<ul style="list-style-type: none"> <li>– Point the remote control at the remote sensor of the unit.</li> <li>– Reduce the distance to the player.</li> <li>– Remove any possible obstacles.</li> <li>– Replace the batteries with new ones.</li> <li>– Check that the batteries are loaded correctly.</li> </ul>
<b>The display is dark.</b>	<ul style="list-style-type: none"> <li>– Press DIM again.</li> </ul>
<b>Low hum or buzz sound.</b>	<ul style="list-style-type: none"> <li>– Place the DVD system as far away as possible from electric devices with interference.</li> </ul>
<b>Low bass response.</b>	<ul style="list-style-type: none"> <li>– Check all speakers for correct polarity.</li> </ul>
<b>The disc tray cannot open and "TRAY LOCKED" is displayed.</b>	<ul style="list-style-type: none"> <li>– Press and hold SOURCE and STOP buttons for more than two seconds.</li> </ul>